

**Instruction Manual**

# JSL-64A 1/32 DIN General Purpose Timer

Version 1.2 (March 2021)

## 1. Overview

This JSL-64 timer can count from 0.01 second to 9999 minutes. Operating function modes include single delay, double delay, and cycle delay. It can count-down or count-up. The timer can be activated automatically when powering up, by front key pad, or via remote switch.

## 2. Specification

- Timer range: 0.01 second to 9999 minutes.
- Timer mode: single delay, double delay, cycle delay, count-up timer.
- Timer trigger: power on, front key pad, or remote switch.
- Timer error: < 1 s/day.
- Power supply: 85 - 260 V AC or DC.
- Power consumption: < 2 W.
- Relay output: 10A at 240 VAC / 30 VDC (resistive load)
- Average relay life: 100,000 times at rated current.
- Operating temperature: 0 - 60°C.
- Humidity: 0 - 95% RH.
- Panel cutout: 22 x 45 mm.
- Outer dimension: 24 x 48 x 75 mm (1" x 2" x 3").

## 3. Front Panel

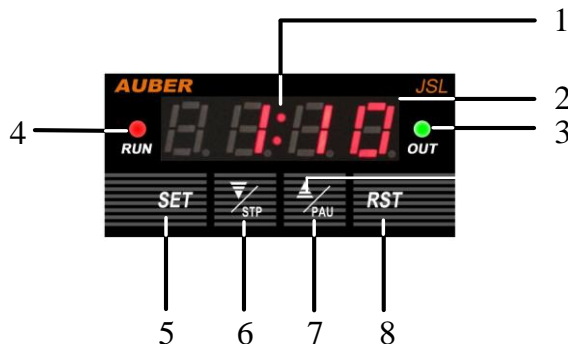

Figure1. Front panel.

1. Time unit indicator (colon sign): Turns on when time format is MM:SS (Minutes: Seconds) or HH:MM (Hours: Minutes) and flashes when the timer is running; turns off when time unit is M (Minutes) or S (Seconds).
2. LED digital display: During normal operation as a timer, it displays the actual time. When timer is stopped, it displays the preset value. During controller setup, it displays parameter value.
3. **OUT** indicator: Turns on when relay is on; turns off when relay is off.
4. **RUN** indicator: Turns on when timer is running; blinking/flashing when timer is paused; turns off when timer is stopped.
5. **SET** key: press it once to set timer and relay delay timer T1/T2 (if applicable. T1 timer shows as t-1, T2 timer shows as t-2); press and hold it for 3 second will enter the programming mode. This key is disabled when timer is running.

6. **DOWN** key / **STP** key: Reduces the value in the programming mode; when the timer is running, press it to stop the timer. (For special stop function in single delayed on mode, please see note 6 on page 3 for details).
7. **UP** key / **PAU** key: Increases the value in the programming mode; when timer is running, press and hold it will pause the timer; the timer will continue running after this key is released.
8. **RST** key: Reset key. When the timer is running, press it will restart the timer. If "RUN" parameter is set to RST, press it will start the timer after powered up.

## 4. Terminal Assignment

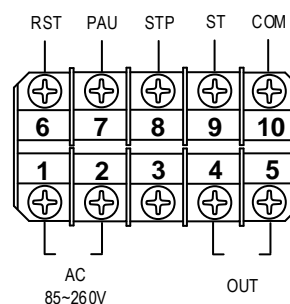

Figure 2. Terminal assignment.

Pin #	Function	Description	Note
<b>Note: pin 1 to pin 5 are high voltage pins.</b>			
1	AC power input	85V ~ 260V AC power input.	
2	AC power input		
3	N.C.	Not connected.	
4	Relay Output	Normally open (NO) relay. The relay action is in synchronize with the OUT indicator.	A
5	Relay Output		
<b>Note: pin 6 to pin 10 are low voltage pins.</b>			
6	Reset	When connected with COM pin, works as the RST key to reset the timer.	B
7	Pause	When connected with COM pin, works as the PAU key to pause the timer.	B
8	Stop	When connected with COM pin, works as the STP key to stop the timer.	B
9	Special Terminal	Special terminal reserved for Espresso Shot Timer (EST) function.	C
10	Common	Common pin.	B

**Note A.** Terminal 4 and 5 are for normally-open (NO) relay output. When this relay is energized (or when the OUT LED is on), pin 4 is connected to pin 5 internally; When the relay is NOT energized (or when the OUT LED is off), pin 4 is disconnected from pin 5. The relay is a "dry switch" that does not provide power by itself. Please see the wiring examples in Section 7.

**Note B.** Pin 10 is the common pin for the pin 6/7/8. There are two ways to operate terminal 6, 7, and 8.

a) Connecting a normally open (NO) momentary push button switch between the pin (6, 7 or 8) to the COM (10). Please note, the function starts when you release (or open) the button of the switch, not when you press down the switch. See Figure 5.

b) Connecting a DC logic signal (TTL or CMOS or voltage in the range from 3 to 30 VDC) between the terminal (6, 7 or 8) to the COM (10). Please note, the function is rising-edge triggered. The logic signal should normally be at high level. The function starts when the signal goes from low to high. If you have an inverted logic signal, you need to connect a NPN transistor between terminal and COM; add 10Kohm resistor to the gate for signal input. See Figure 6.

The function of all these terminals is accomplished by the rising phase of control signal. If the control signal is from a momentary NO switch that is connected to the terminal, the action starts when switch is released (from close to open). When the control signal is from another digital device, the action starts when voltage goes from low to high.

**Note C.** Pin 9 is a special terminal reserved for Espresso Shot Timer function (when FUNC is set to EST) in the JSL-64A and JSL-64A-EST. When it is connected with the COM pin, the timer resets its display and start counting up from zero. When it is disconnected from COM pin, the counting stops.

**5. Getting Started**

**5.1 Powering up the timer**

To power up the timer, simply connect 120 VAC or 220 VAC power to pin 1 and 2. It is recommended to use a power supply or power cord that has an ON/OFF switch on it.

**5.2 General operations**

A brief description of the keys on the timer are described below. Please also refer to Section 6 for details of parameter **RUN**, **STOP**, and **PAUS**. The settings of these parameters can affect the actual functions of STP, PAU, and RST key.

Key	Action
SET	<ul style="list-style-type: none"> <li>Shot-press: bring up the set value; select parameter; save value.</li> <li>Long-press: bring up the parameter menu.</li> <li>No action while timer is running.</li> </ul>
▼ /STP	<ul style="list-style-type: none"> <li>Stops the timer from counting time.</li> <li>May stops the relay output depending on the STOP setting.</li> <li>Decrease value.</li> </ul>
▲ /PAU	<ul style="list-style-type: none"> <li>Pauses the timer counting.</li> <li>Increase value.</li> </ul>
RST	<ul style="list-style-type: none"> <li>Clears timer display.</li> <li>May restart the timer if parameter RUN = RST.</li> </ul>

**5.3 Accessing the parameters**

To bring up the parameter menu, long press the SET key for 3 seconds till the display shows "FUNC". Use UP or DOWN arrow key to scroll the parameter list. Use SET key to select or check the value of a parameter. Use UP or DOWN arrow key to change the value of any parameter, and press the SET again to save the new value then go back to the parameter list.

Please refer to the Section 6 for the details of each parameter. Figure below shows how to access the menu.

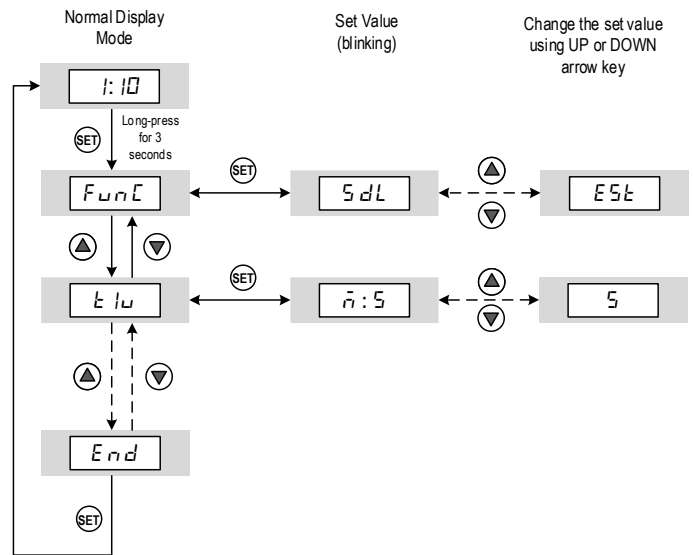

Figure 3. Flow chart of how to change the parameter values.

**5.4 Changing the set values**

Depending on the timer function you choose, you may need to adjust the set values **T1** and **T2**.

If you use the Single Delay function (**FUNC = SDL**), you'll need to adjust **T1**. If you use Delayed Interval or Cycle function (**FUNC = DINT or CYCL**), you'll need to adjust **T1** and **T2**. If you use the Espresso Shot Timer function (**FUNC = EST**), you don't need to adjust the set values. The flow chart below shows how to adjust the set values.

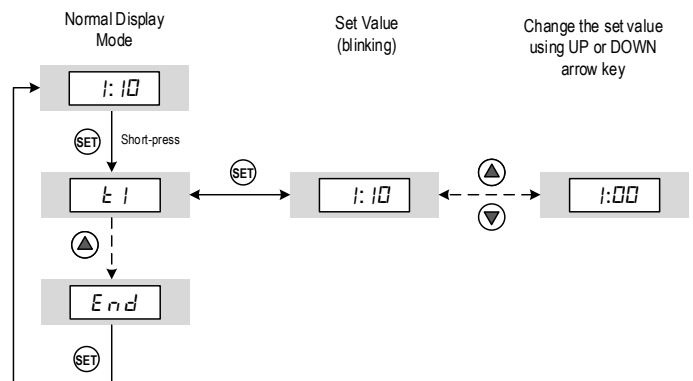

Figure 4. Flow chart of how to change set values on the timer.

**6. Parameter Settings**

All parameters are listed in the table below.

Press and hold SET key for 3 seconds to enter the menu mode. For each parameter setting, use UP or DOWN key to select different programming values. Press SET key to confirm then exit. Please check figure 3 for details. For the definition of each programming value, see Table 1.

**Table 1. Parameter Description.**

Code	Description	Range	Initial	Note
<b>Set Values (Short-press SET key)</b>				
T1	Set value for T1		1: 10	1
T2	Set value for T2		1: 10	2
<b>Parameters (Long-press SET key for 3 seconds)</b>				
FUNC	Timer function, operating mode	SDL, DINT, CYCL, EST *	SDL	3 *
T1U	T1 timer unit	S, M:S, M, H:M	S	4
T2U	T2 timer unit		S	
TDIR	Timer counting direction	UP, DN	DN	5
OUT	Relay output mode	OFDL, ONDL	OFDL	6
RUN	Timer triggering action	RST, PU	RST	7
STOP	Relay action when STP key is pressed	0, 1	0	8 **
PAUS	Relay action when PAU key is pressed	0, 1	1	9

\* Please note that ESP function is a new feature added to JSL-64A. It is not available in JSL-64.

\*\* Please note that STOP parameter will only appear in the menu when FUNC = SDL and OUT = ONDL.

**Details about each parameter**

**Note 1. T1** is the set value in Single Delay (SDL) mode. It is also the first set value in in Delayed Interval Mode (DINT) and the Cycled Mode (CYCL) mode.

**Note 2. T2** is the second set value in Delayed Interval Mode (DINT) or in the Cycled Mode (CYCL). This parameter will only be displayed if the Timer Mode FUNC is set to either DINT or CYCL mode.

**Note 3: FUNC** is the timer operating mode, it can be set to **SDL, DINT, CYCL,** or **EST.**

**SDL** (Single Delay): The timer counts a single period of time that is defined in T1. The relay can either be turned on during this period of timer or it can be turned on at the end of this period of time, depends on the **OUT** setting. When **OUT = OFDL**, the relay turns on at the beginning when timer starts counting, and turns off when the counting stops. When **OUT = ONDL**, the relay

stays off when timer starts counting, and the relay turns on when the timer reaches the set value till the RST (reset) key is pressed or when the power to the device is cycled. Please refer to Note 6 for details about **OUT** parameter.

In Single Delay and On-Delay mode (i.e., **FUNC = SDL, OUT = ONDL**), a special parameter **"STOP"** will appear in the parameter menu. For details please refer to the Note 8 below.

**DINT** (Delayed Interval): The timer will count time for two periods of time, T1 and T2, and then stops. Relay action depends on the **OUT** setting. When **OUT = OFDL**, the relay turns on at the end of T1, stays on during T2 time, and then turns off at the end of T2 time. When **OUT = ONDL**, the relay turns on at the beginning at T1 time, turns off at the end of T1 time, stays off during T2, and then turns on again at the end of T2 time. This is a single action process.

**CYCL** (Cycle): The timer will repeat a counting cycle that consists of two periods of time, T1 and T2. The relay turns on/off during each cycle depending on the **OUT** setting. When **OUT = OFDL**, the relay turns on at the end of T1, stays on during T2 time, and then turns off at the end of T2 time. When **OUT = ONDL**, the relay turns on at the beginning at T1 time, turns off at the end of T1 time, stays off during T2, and then turns on again at the end of T2 time. This cycle will be immediately repeated till it is stopped or reset.

**EST** (Espresso Shot Timer): This is a special mode designed for counting the shot time (brew time) on an espresso machine. The timer display resets to zero and it starts counting up when the pin 9 and 10 are shorted together. The timer stops counting when terminal 9 and 10 are disconnected. The time unit is determined by the parameter T1U. Pressing the RST key can clear the display. The relay output, STP key, and PAU key are not functional in this mode. The settings of parameter T2U, TDIR, OUT, RUN, STOP, and PAUS are irrelevant to this mode.

**Note 4. T1U and T2U** define the time unit for T1 and T2. (Note, T2 is only available when **FUNC = DINT** or **CYCL**).

Settings	Description	Range
<b>S</b>	Seconds	0.01 s ~ 99.99 s
<b>M:S</b>	Minutes: Seconds	1 s ~ 99 m 59 s
<b>M</b>	Minutes	1 m ~ 9999 m
<b>H:M</b>	Hours: Minutes	1 m ~ 99 h 59 m

**Note 5. TDIR** determines the Timer Counting Direction.

- UP:** counting up.
- DN:** counting down.

**Note 6. OUT** determines the relay output status as the timer runs.

**OFDL** (off-delay): the relay will turn ON when timer starts counting and the relay will turn OFF when the timer reaches the set value.

**ONDL** (on-delay): the relay will stay OFF when the timer starts counting and the relay will turn ON when the timer reaches the set value.

**Note 7. RUN** determines how does the timer start counting.

- PU** (power up): the timer starts counting when the device is powered up.
- RST** (reset): the timer starts when reset button is pressed and released.

**Note 8.** The parameter **STOP** defines the relay output status when STP key is pressed during timer **T1** is counting.

(\*\* The parameter **STOP** parameter will only appear in the menu when **FUNC = SDL** and **OUT = ONDL**.)

When running the single-delay (**FUNC = SDL**) and on-delay mode (**OUT = ONDL**), depending on the applications, user may want the output relay (normally open) to stay at off position (which is the initial status), or, stay at on position (which is the relay's final status) when the STP key is pressed. Here are two examples. A) Some users use the timer to turn on a buzzer at the end of a process for notification purpose. They want to be able to disable the buzzer (change to the initial status) by simply pressing down the stop button once he acknowledged the notification. B) Some users want to delay the process of turning on a load. But sometimes, they may want to cancel the delay (change to the final state) to start the oven by pushing the stop key.

In order to satisfy these two conflict requirements, a special parameter for stop function, **STOP** will show up in the parameter menu when both **ONDL** (on delay) and **SDL** (single delay) are selected, **STOP** can be selected as 0 (default) or 1. When it is set to 0, during the delay, stop signal will set relay to the final state (pulled-in). When it is set to 1, during the delay, stop signal will set the relay to the initial state (dropped-out). When the time delay is finished and relay pulled in, user can reset the relay to the initial state by sending a stop signal, regardless of the **STOP** setting.

**Note 9.** The parameter **PAUS** defines whether the relay output (pin 4 and 5) should be changed from ON to OFF while the timer is running and the PAU key is pressed. When **PAUS = 0**, pressing the PAU key will only pause the timer and it will NOT affect the relay output status. When **PAUS = 1**, pressing the PAU key will not only pause the timer but also change a relay output status from ON to OFF. However, it will not affect relay status if the relay is OFF.

**7. Wiring Examples**

**1) Signal controlled by switches**

Power (120 or 240V AC) is sent to pin 1 and 2. The external reset (RST) and pause (PAU) switch should be momentary type. They are needed only if you want to control the timer remotely. Otherwise, you can use the front keys on the timer. These switches can also be replaced with a control signal from computer or other control devices. **The alarm speaker used in this example is also optional. It is to show how to wire the output. You can substitute it with any output such as a coffee grinder.** The output terminals (#4 and 5) are from an internal relay. It is a dry switch that does not provide the power by itself. In this case, the alarm is powered by the 120VAC. The external switch connected to the alarm is for disabling the sound if needed.

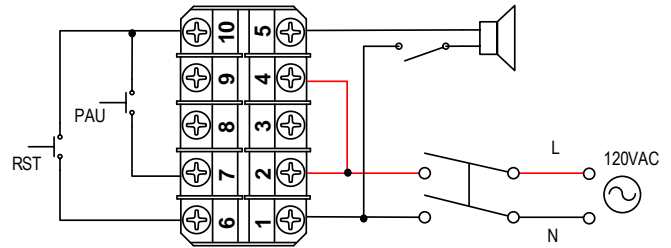

Figure 5. Connecting reset switch and pause switch to JSL-64A.

**2) Signal controlled by DC logic signal.**

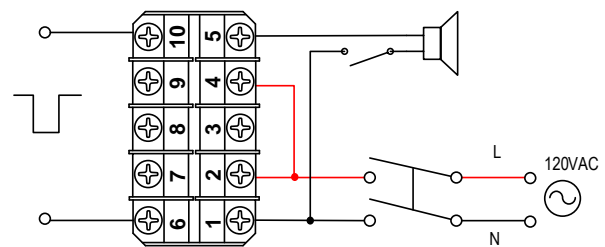

Figure 6. Rising-edge triggered signal.

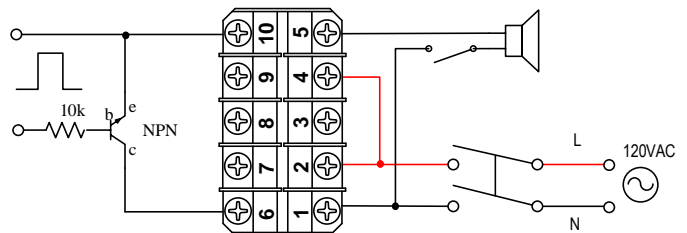

Figure 7. Inverted logic signal.

**3) Espresso shot timer**

In this example, we will use a small relay (120V coil voltage and a pair of normally open NO contacts) with JSL-64A timer. The espresso machine use 120VAC power and it has a vibration pump that runs at 120VAC. To use this timer as an espresso shot timer, please set **FUNC = EST**, and **T1U = S**. Then press RST key to clear the screen. The display will show "0.00" as shown in the Figure 8 below. Wiring of the timer, relay, and the pump is shown in the Figure 9 below.



Figure 8. The display of the JSL-64A timer in ESP mode.

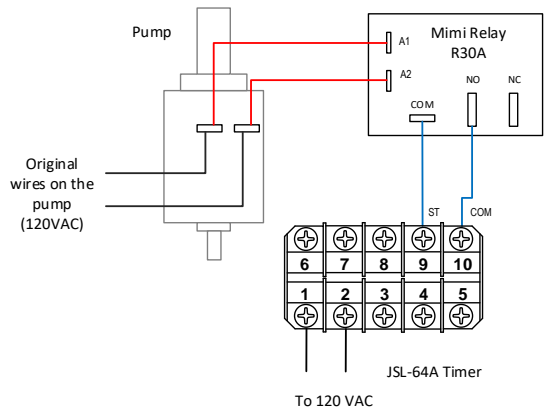

Figure 9. Wiring diagram of using JSL-64A timer as a shot timer on espresso machine.

Whenever the pump is activated, the mini relay R30A's coil will be energized to pull its NO contacts in, so the pin 9 and 10 of the timer are shorted together, the timer will start counting time up in seconds. The timer stops counting when the pump is deactivated.

**8. Timing Diagrams**

The following diagrams show how the relay output status is affected by RST, PAU, and STP key/terminals under different **FUNC** (Timer Function) and **OUT** (Relay Output Mode) settings.

Please note that: 1) "RUN" is set to "RST" in following examples, powering up to start the timer is not discussed here. 2) Timer starts counting from the moment when reset key/switch is released or input signal (TTL) is rising from low to high. 3) Timer display stops counting as soon as stop key/switch is pressed (voltage from high to low), but relay output will only be triggered when stop key/switch is released (voltage from low to high).

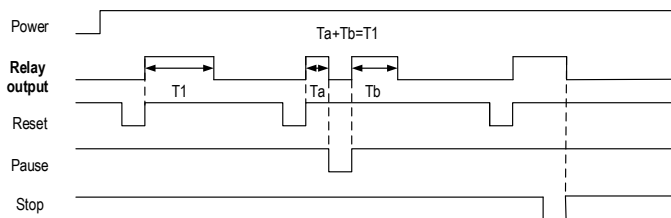

Figure 10 (a). Single delay and off-delay (FUNC = SDL, OUT = OFDL).

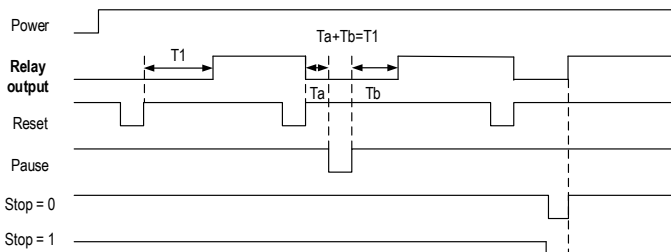

Figure 10 (b). Single delay and on-delay (FUNC = SDL, OUT = ONDL) (for the STOP parameter, please see Note 8 on page 2 for details).

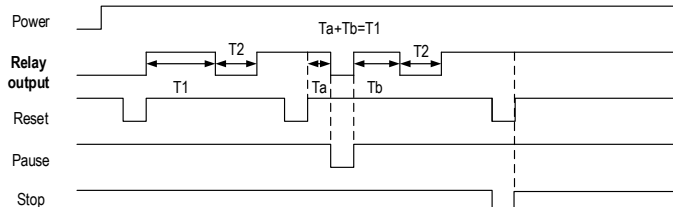

Figure 10 (c). Delayed interval and off-delay (FUNC = DINT, OUT = OFDL).

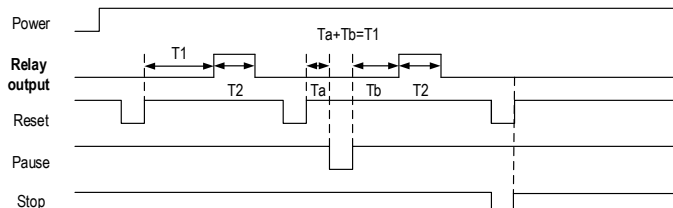

Figure 10 (d). Delayed interval and on-delay (FUNC = DINT, OUT = ONDL).

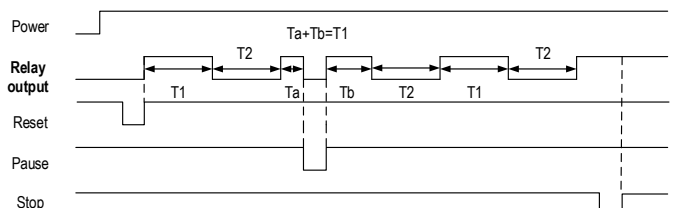

Figure 10 (e). Cycled and off-delay (FUNC = CYCL, OUT = OFDL).

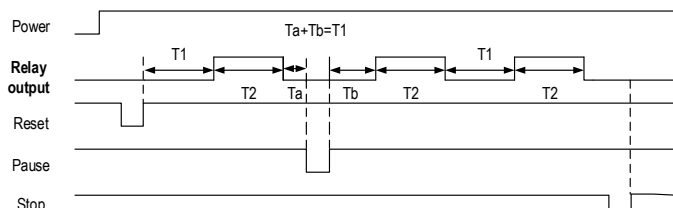

Figure 10 (f). Cycled and on-delay (FUNC = CYCL, OUT = ONDL).

(END)

**Auber Instruments**

5755 North Point Parkway, Suite 99  
Alpharetta, GA 30022, USA

[www.auberins.com](http://www.auberins.com)

E-mail: [info@auberins.com](mailto:info@auberins.com) Tel: 770-569-8420

Copyright 2007-2021, Auber Instruments. All Rights Reserved.  
No part of this manual shall be copied, reproduced, or transmitted in any way without the prior, written consent of Auber Instruments. Auber Instruments retains the exclusive rights to all information included in this document.